

CEP1012L/CEB1012L

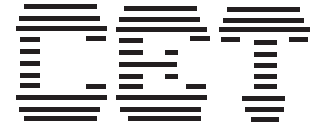

PRELIMINARY

4

N-Channel Enhancement Mode Field Transistor

FEATURES

- 120V , 10A , $R_{DS(ON)}=120m\Omega$ @ $V_{GS}=5V$
- Super high dense cell design for extremely low $R_{DS(ON)}$.
- High power and current handling capability.
- TO-220 & TO-263 package.

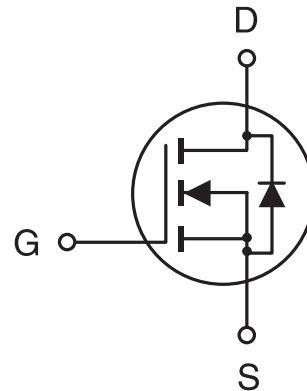

ABSOLUTE MAXIMUM RATINGS (Tc=25°C unless otherwise noted)

Parameter	Symbol	Limit	Unit
Drain-Source Voltage	V _{DS}	120	V
Gate-Source Voltage	V _{GS}	±20	V
Drain Current-Continuous -Pulsed	I _D	10	A
	I _{DM}	40	A
Drain-Source Diode Forward Current	I _S	10	A
Maximum Power Dissipation @T _c =25°C Derate above 25°C	P _D	100	W
		0.8	W/°C
Operating and Storage Temperature Range	T _J , T _{STG}	-65 to 150	°C

THERMAL CHARACTERISTICS

Thermal Resistance, Junction-to-Case	R _{θJC}	1.25	°C/W
Thermal Resistance, Junction-to-Ambient	R _{θJA}	62.5	°C/W

CEP1012L/CEB1012L

ELECTRICAL CHARACTERISTICS (Tc=25°C unless otherwise noted)

4

Parameter	Symbol	Condition	Min	Typ	Max	Unit
OFF CHARACTERISTICS						
Drain-Source Breakdown Voltage	BV _{DSS}	V _{GS} =0V, I _D =250μA	120			V
Zero Gate Voltage Drain Current	I _{DSS}	V _{DS} =120V, V _{GS} =0V			25	μA
Gate-Body Leakage	I _{GSS}	V _{GS} =±20V, V _{DS} =0V			±100	nA
ON CHARACTERISTICS^a						
Gate Threshold Voltage	V _{GS(th)}	V _{DS} =V _{GS} , I _D =250μA	1	1.6	3	V
Drain-Source On-State Resistance	R _{DS(ON)}	V _{GS} =5V, I _D =10A			120	mΩ
On-State Drain Current	I _{D(ON)}	V _{GS} =10V, V _{DS} =10V	10			A
Forward Transconductance	g _{FS}	V _{DS} =10V, I _D =5A		6		S
DYNAMIC CHARACTERISTICS^b						
Input Capacitance	C _{ISS}	V _{DS} =25V, V _{GS} =0V f=1.0MHz		602	800	pF
Output Capacitance	C _{OSS}			155	210	pF
Reverse Transfer Capacitance	C _{RSS}			67	100	pF
SWITCHING CHARACTERISTICS^b						
Turn-On Delay Time	t _{D(ON)}	V _{DD} =30V, I _D =15A, V _{GS} =5V, R _{GEN} =51Ω		42	60	ns
Rise Time	t _r			84	120	ns
Turn-Off Delay Time	t _{D(OFF)}			56	80	ns
Fall Time	t _f			35	50	ns
Total Gate Charge	Q _g	V _{DS} =96V, I _D =10A, V _{GS} =10V		25	60	nC
Gate-Source Charge	Q _{gs}			5		nC
Gate-Drain Charge	Q _{gd}			7		nC

CEP1012L/CEB1012L

ELECTRICAL CHARACTERISTICS ($T_c=25^\circ\text{C}$ unless otherwise noted)

4

Parameter	Symbol	Condition	Min	Typ	Max	Unit
DRAIN-SOURCE DIODE CHARACTERISTICS^a						
Diode Forward Voltage	V_{SD}	$V_{GS} = 0V, I_s = 10A$		0.86	1.2	V

Notes

a. Pulse Test: Pulse Width $\leq 300 \mu s$, Duty Cycle $\leq 2\%$.

b. Guaranteed by design, not subject to production testing.

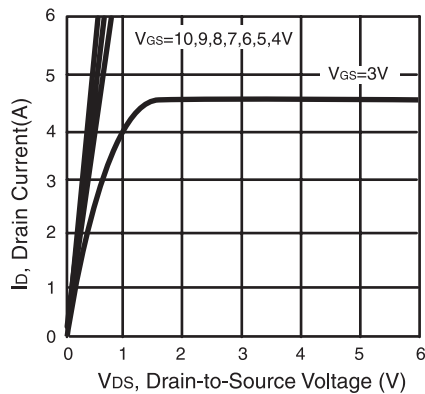

Figure 1. Output Characteristics

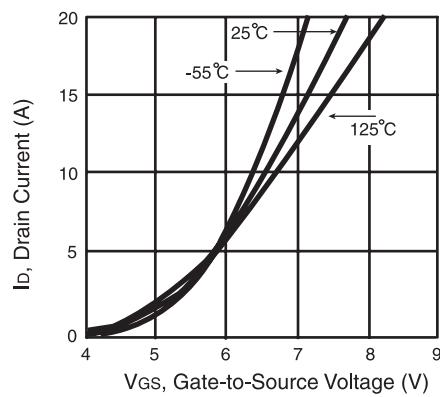

Figure 2. Transfer Characteristics

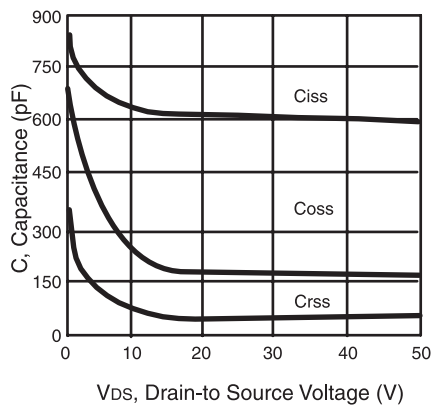

Figure 3. Capacitance

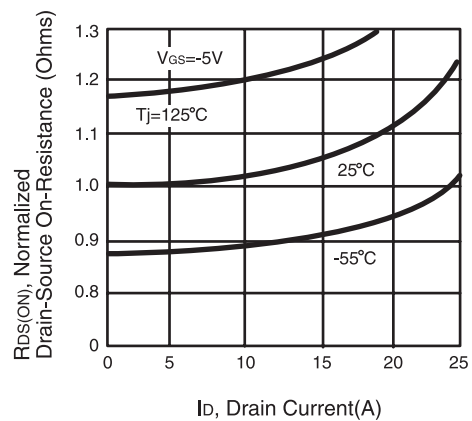

Figure 4. On-Resistance Variation with Drain Current and Temperature

CEP1012L/CEB1012L

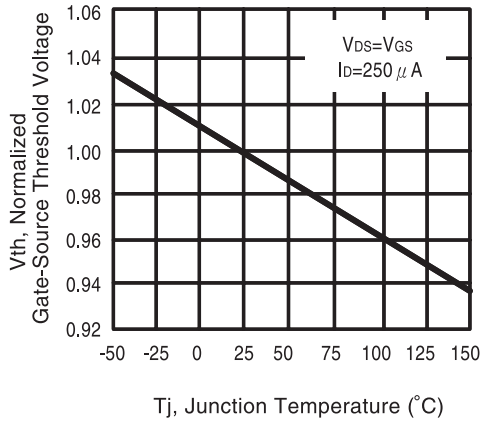

Figure 5. Gate Threshold Variation with Temperature

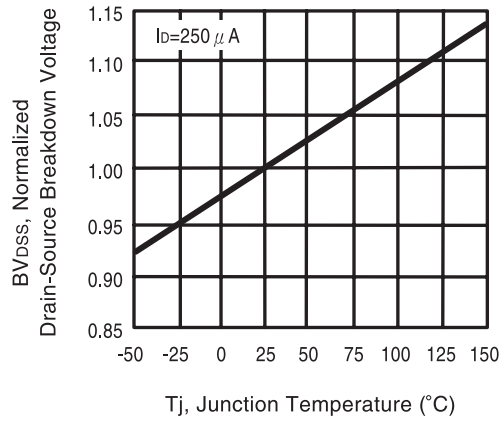

Figure 6. Breakdown Voltage Variation with Temperature

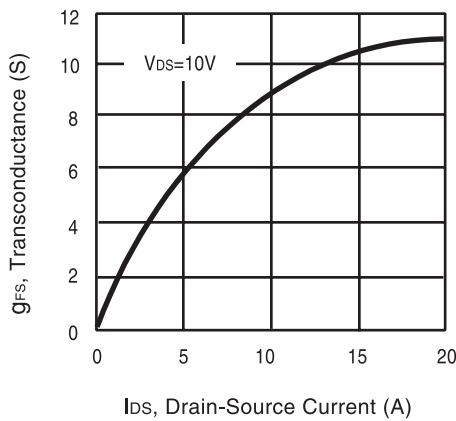

Figure 7. Transconductance Variation with Drain Current

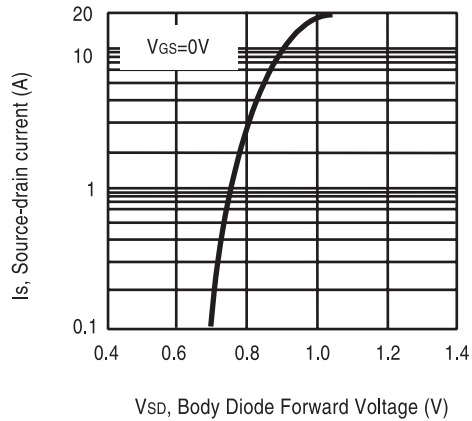

Figure 8. Body Diode Forward Voltage Variation with Source Current

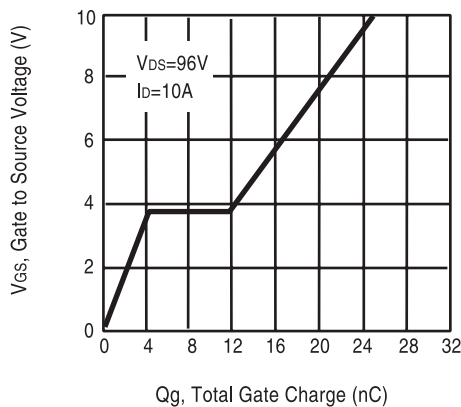

Figure 9. Gate Charge

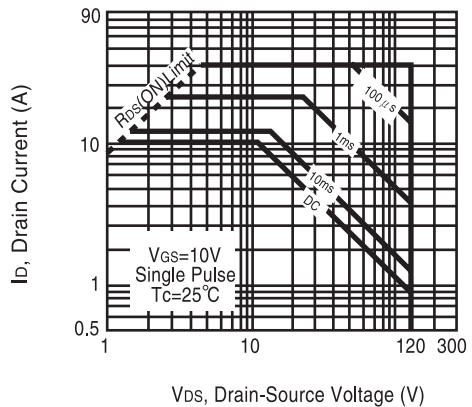

Figure 10. Maximum Safe Operating Area

CEP1012L/CEB1012L

4

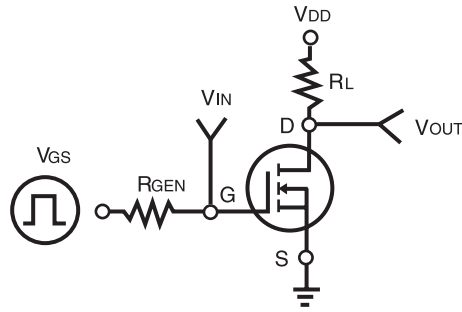

Figure 11. Switching Test Circuit

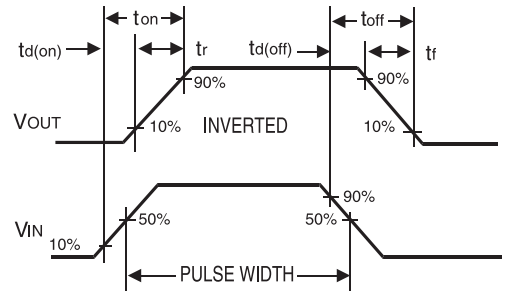

Figure 12. Switching Waveforms

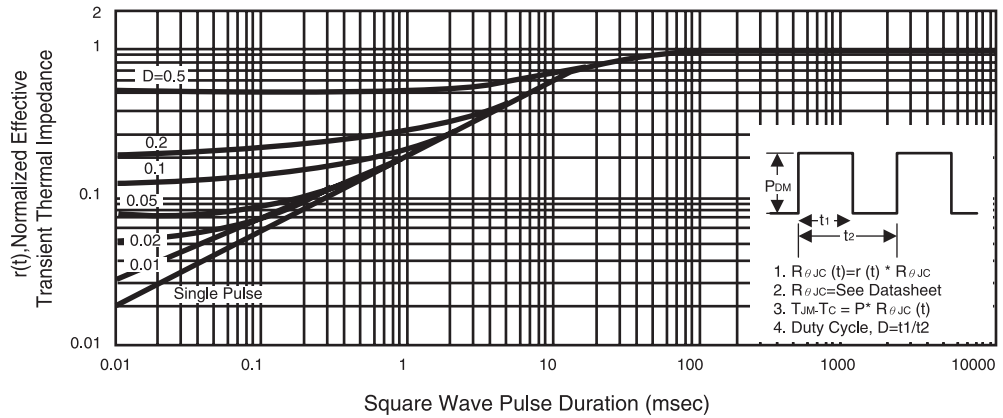

Figure 13. Normalized Thermal Transient Impedance Curve